

TDS
Technical Data Sheet

Release Date
2023



Designed by Fernando Urquijo and Giorgio Macola, Mood is a family of furnishings for individual and group workspaces with a functional and comfortable feel. Each of the components is characterized by a strong identity and precise purpose, allowing them to stand alone or to become elements of refined furnishing compositions that create warm, welcoming atmospheres.

The Mood series consists of desks in various shapes and sizes, carefully designed in every detail, as well as drawer pedestals, cabinets, and bookcases.

Tables

Characterised by lightness of form and refined finishes, the tops feature a natural wood finish with bevelled edges in solid wood. Two aluminium profiles fixed to the undersides of the tops permit the vertical supports to be positioned freely anywhere along their length.

In the case of the round, square, rectangular, and elliptical meeting tables, the vertical support consists of a single central leg. Multiple modules can be configured to create large-format tables, ideal for large meeting spaces.

The leg consists of a disk in contact with the floor, a flange, and a steel column. In the case of the meeting tables, the leg also serves as a riser for the cable management system, completed by cable trays mounted below the top and access hatches mounted flush with the top.

The diameter of the floor disks, flanges, and columns varies depending on the dimensions of the tops. Special hardware can be added to the drawer pedestals for use as vertical supports for the workstations.

Containers

The containers of the Mood series consist of drawer pedestals, open cabinets and cabinets with doors, and modular bookcases. The drawer pedestals, in powder-coated sheet metal, are available with three or four drawers.

The tall bookcases, with a drawer at the base, are available with open shelving, a solid door, or a glass door. The powder-coated structure contrasts with the shelving and the rear panel in wood.

TABLE TOP EDGE DETAIL

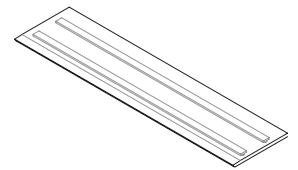
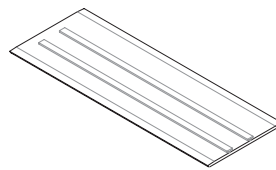
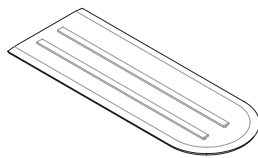
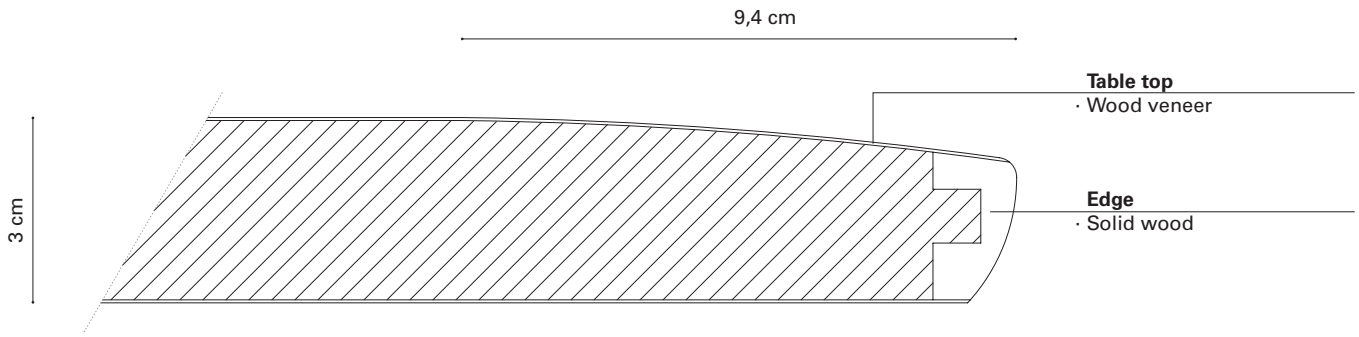

TABLE TOPS

Table tops with semi circular end with 3 sloped edges type B

200×80×H3 cm
Q T 200 80 B ..

240×90×H3 cm
Q T 240 90 B ..

Rectangular table tops with 2 sloped edges type C

200×80×H3 cm
Q T 200 80 C ..

240×90×H3 cm
Q T 240 90 C ..

Rectangular table tops with 1 sloped edge type E

200×60×H3 cm
Q T 200 60 E ..

240×60×H3 cm
Q T 240 60 E ..

260×60×H3 cm
Q T 260 60 E ..

280×60×H3 cm
Q T 280 60 E ..

200×80×H3 cm
Q T 200 80 E ..

240×80×H3 cm
Q T 240 80 E ..

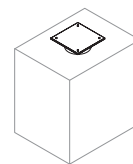
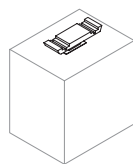

LEGS FOR TABLE TOPS

Bases for table tops

For table tops depth 60/80 cm
50x50xH69 cm
Q R 80 ..

For table tops depth 90 cm
55x55xH69 cm
Q R 90 ..

Pedestal support, height-adjustable into three positions H69/72/75 cm

12x40 cm
Q R C ..

Pedestal fixed support

23x23 cm
Q R CR ..

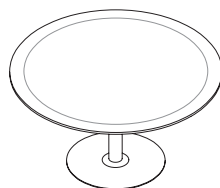
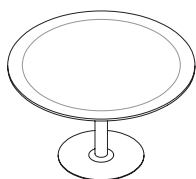

ROUND TABLES

Round tables composed of n.1 table top (QT 120 R) and n.1 leg (Q R 120)

120x120xH72 cm
Q DM 120 R ..

Round tables composed of n.1 table top (QT 140 R) and n.1 leg (Q R 140)

140x140xH72 cm
Q DM 140 R ..

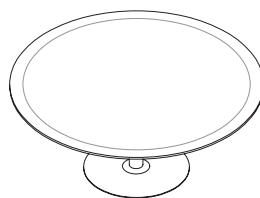
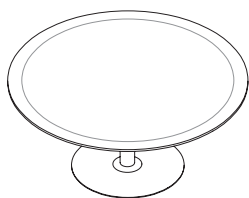
**Round tables composed of n.1 table top (QT 160 R) and n.1 leg (Q R 160)**

160x160xH72 cm
Q DM 160 R ..

Round tables composed of n.1 table top (QT 180 R) and n.1 leg (Q R 180)

180x180xH72 cm
Q DM 180 R ..

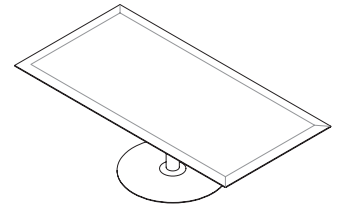
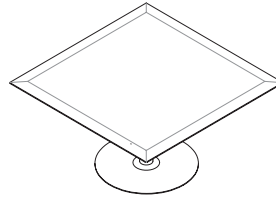
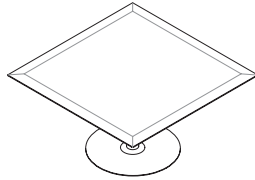

SQUARED AND RECTANGULAR TABLES

Squared tables composed of n.1 table top (QT 140 Q) and n.1 leg (Q R 160)

140x140xH72 cm
Q DM 140 Q ..

Squared tables composed of n.1 table top (QT 160 Q) and n.1 leg (Q R 160)

160x160xH72 cm
Q DM 160 Q ..

Rectangular tables composed of n.1 table top (QT 240 120 Q) and n.1 leg (Q R 320)

240x120xH72 cm
Q DM 240 120 Q ..

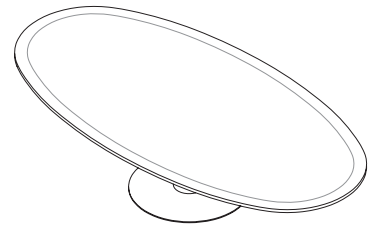
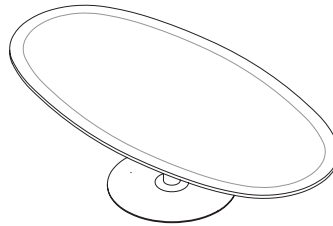
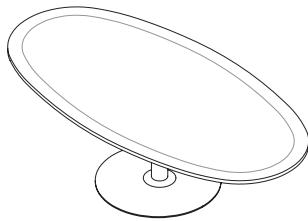

ELLIPTICAL TABLES

Elliptical tables composed of n.1 table top (QT 240 120) and n.1 leg (Q R 240)

240x120xH72 cm
Q DM 240 120 E ..

Elliptical tables composed of n.1 table top (QT 280 140) and n.1 leg (Q R 320)

280x140xH72 cm
Q DM 280 140 E ..

Elliptical tables composed of n.1 table top (QT 320 160) and n.1 leg (Q R 320)

320x160xH72 cm
Q DM 320 160 E ..

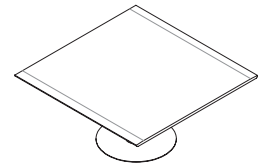
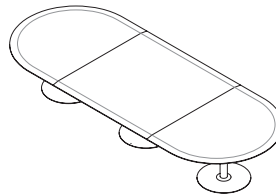
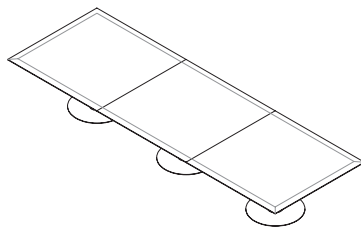

LARGE MEETING TABLES

Rectangular tables composed of n.1 table top (QT 480 160 Q) and n.3 legs (Q R 160)

480x160xH72 cm
Q DM 480 160 Q ..

Oval tables composed of n.1 table top (QT 400 160 S) and n.3 legs (Q R 140)

400x160xH72 cm
Q DM 400 160 S ..

Intermediate tables for (QT 480 160 Q) and (QT 400 160 S), composed of n.1 table top (QT 160 QI) and n.1 leg (Q R 160)

160x160xH72 cm
Q DM 160 160 I ..

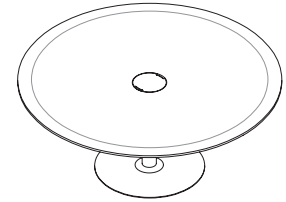
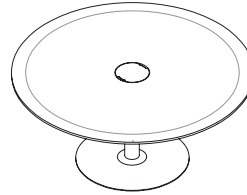
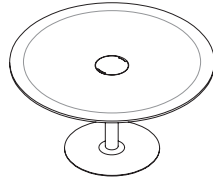

ROUND TABLES PRE-ARRANGED
FOR ELECTRIFICATION

Round tables composed of
n.1 table top (QT 140 RW),
n.1 leg (Q R 140 W),
n.1 flip access door (P D P CAB Z01)

140x140xH72 cm
Q DM 140 R W ..

Round tables composed of
n.1 table top (QT 160 RW),
n.1 leg (Q R 160 W),
n.1 flip access door (P D P CAB Z01)

160x160xH72 cm
Q DM 160 R W ..

Round tables composed of
n.1 table top (QT 180 RW),
n.1 leg (Q R 180 W),
n.1 flip access door (P D P CAB Z01)

180x180xH72 cm
Q DM 180 R W ..

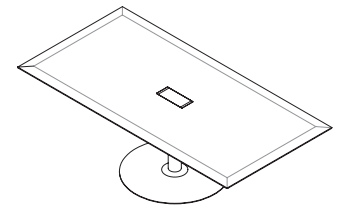
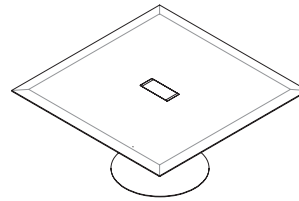
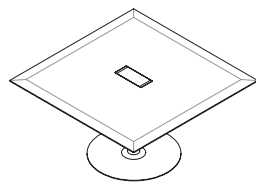

SQUARED AND RECTANGULAR
TABLES PRE-ARRANGED FOR
ELECTRIFICATION

Squared tables composed of
n.1 table top (QT 140 QW),
n.1 leg (Q R 160 W),
n.1 flip access door (P D P CAB Z06)

140x140xH72 cm
Q DM 140 Q W ..

Squared tables composed of
n.1 table top (QT 160 Q),
n.1 leg (Q R 160 W),
n.1 flip access door (P D P CAB Z06)

160x160xH72 cm
Q DM 160 Q W ..

Rectangular tables composed of
n.1 table top (QT 240 120 QW),
n.1 leg (Q R 320 W),
n.1 flip access door (P D P CAB Z06)

240x120xH72 cm
Q DM 240 120 Q W ..

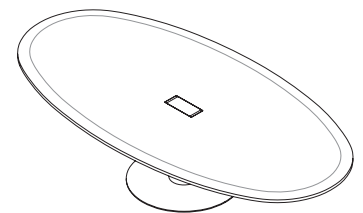
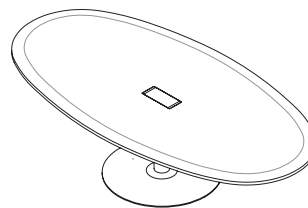
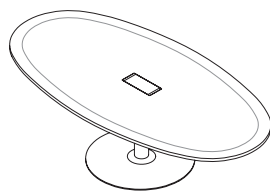

ELLIPTICAL TABLES
PRE-ARRANGED FOR
ELECTRIFICATION

Elliptical tables composed of
n.1 table top (QT 240 120 W),
n.1 leg (Q R 240 W),
n.1 flip access door (P D P CAB Z06)

240x120xH72 cm
Q DM 240 120 E W..

Elliptical tables composed of
n.1 table top (QT 280 140 W),
n.1 leg (Q R 320 W),
n.1 flip access door (P D P CAB Z06)

280x140xH72 cm
Q DM 280 140 E W..

Elliptical tables composed of
n.1 table top (QT 280 160 W),
n.1 leg (Q R 320 W),
n.1 flip access door (P D P CAB Z06)

320x160xH72 cm
Q DM 320 160 E W..

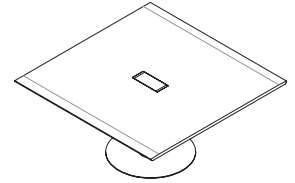
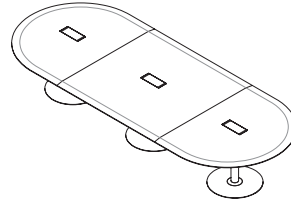
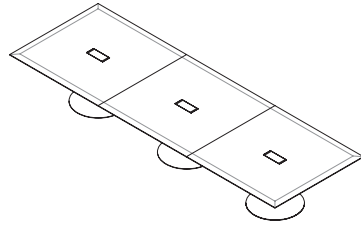

LARGE MEETING TABLES
PRE-ARRANGED FOR
ELECTRIFICATION

Rectangular tables composed of
n.1 table top (QT 480 160 Q W),
n.3 legs (Q R 160 W),
n.3 flip access doors (P D P CAB Z06)

480x160xH72 cm
Q DM 480 160 Q W ..

Oval tables composed of
n.1 table top (QT 400 160 S W),
n.3 legs (Q R 140 W),
n.3 flip access doors (P D P CAB Z06)

400x160xH72 cm
Q DM 400 160 S W ..

**Intermediate tables for (QT 480 160 Q)
and (QT 400 160 S), composed of**
n.1 table top (QT 160 I W),
n.1 leg (Q R 160 W),
n.1 flip access door (P D P CAB Z06)

160x160xH72 cm
Q DM 160 160 I W ..

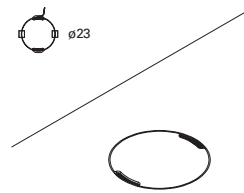
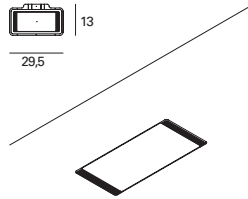

FLIP ACCES DOOR
FOR WIRING

Rectangular flip access door
Same as top finish,
for laminate and veneer top.
Specify the position.

29,5x13xH3 cm
P D P CAB Z06 ..

Round flip access door
Same as top finish,
for laminate and veneer top.
Specify the position.

23x23xH2 cm
P D P CAB Z01 ..

SECTION TABLES PRE-ARRANGED FOR ELECTRIFICATION

Flip acces door

Undertop basket

Cable passage in the leg

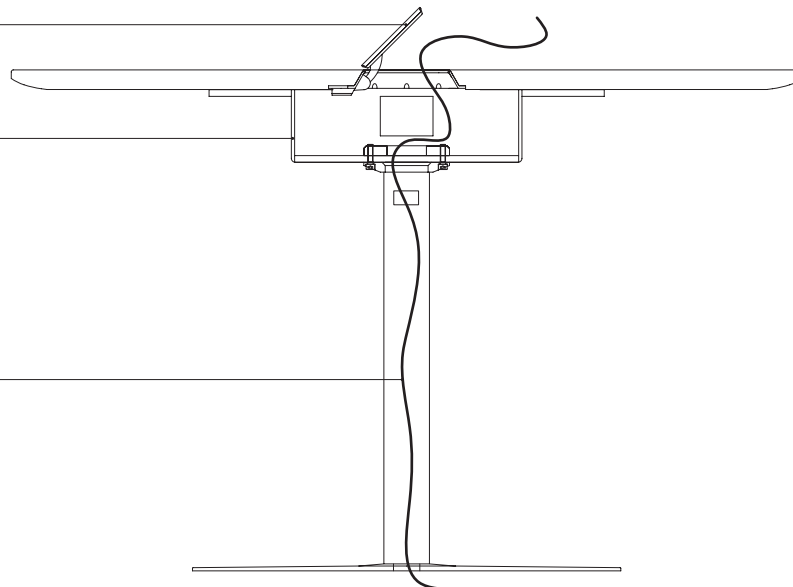

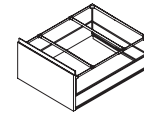
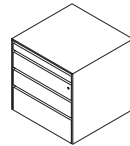
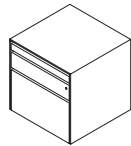

PEDESTALS AND CABINETS

3 drawers cabinet

60x60xH62 cm
Q CB 60 60 C3 ..

90x90xH62 cm
Q CB 90 60 C3 ..

4 drawers cabinet

60x60xH62 cm
Q CB 60 60 C4 ..

90x90xH62 cm
Q CB 90 60 C4 ..

Filing frame

50x39xH24 cm
D DS 600 ..

80x39xH24 cm
D DS 601 ..

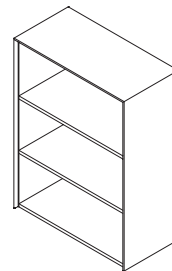
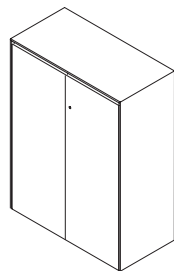

Cabinet with doors

90x45xH62 cm
Q MA 90 60 ..

90x45xH122 cm
Q MA 90 120 ..

90x45xH182 cm
Q MA 90 180 ..

Open cabinet

90x45xH62 cm
Q MG 90 60 ..

90x45xH122 cm
Q MG 90 120 ..

90x45xH182 cm
Q MG 90 180 ..

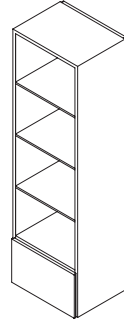
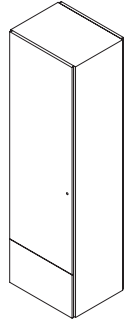

HIGH BOOKCASES

High bookcase with hinged door

60x48xH203 cm
Q EM 060 203 A ..

High open bookcase

60x48xH203 cm
Q EM 060 203 G ..

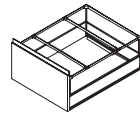
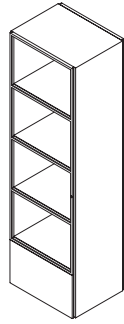
**High bookcase with glass door**

60x48xH203 cm
Q EM 060 203 V ..

Filing frame

50x39xH24 cm
D DS 522 60 48 ..

TABLE TOP FINISHES

Standard natural veneer
(certified genuine wood
from Europe - Canada - USA)



AS
Sycamore



PE
Pearwood



NO
National Walnut

BASED COMPOSED OF GROUND DISK / FLANGE AND COLUMN FINISHES

Epoxy powder coating



NP
Ground disk:
Black painting (NE)
Flange and column:
Pewter painting (MP)



NC
Ground disk:
Black painting (NE)
Flange and column:
Burnished metal (BC)



S9
Ground disk:
Sand-blasted metal (SB)
Flange and column:
Pewter painting (MP)



SC
Ground disk:
Sand-blasted metal (SB)
Flange and column:
Burnished metal (BC)

COMBINATIONS OF TABLES TOP/STRUCTURES FINISHES

Standard natural veneer
Epoxy powder coating

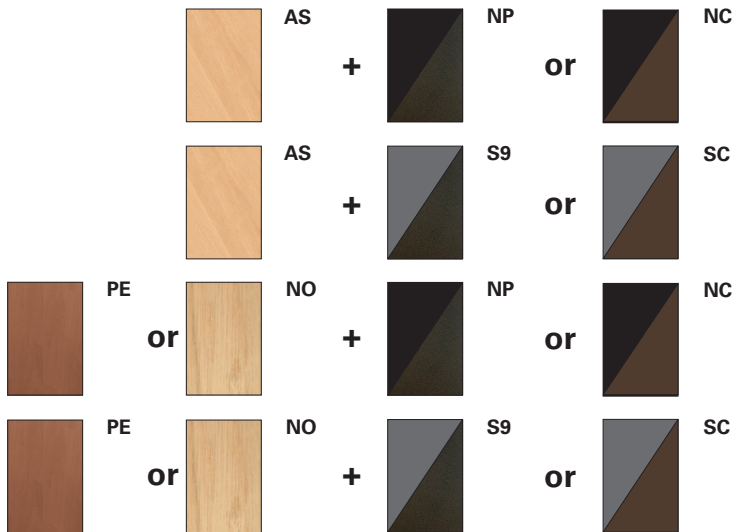

For combinations of table tops/structure,
it is necessary to specify when ordering
the finish of the structure

For other finishes,
please contact our Sales Department

PEDESTAL AND CABINETS FINISHES

Epoxy powder coating



ME
Metallic Grey painting

HIGH BOOKCASES FINISHES

Epoxy powder coating



MO
Metallic Grey painting (ME)
Pearwood (PE)



MC
Metallic Grey painting (ME)
National Walnut (NO)



MS
Metallic Grey painting (ME)
Sycamore (AS)



ISO 9001



ISO 14001

UniFor has management system certified according to UNI EN ISO 9001 and UNI EN ISO 14001. The products are in conformance with the Italian decree law DLGS 81:2008 and with all of the principal regulations applicable to the various types of products.

The products described in this catalog are made with class E1 materials (low formaldehyde content) and are Greenguard® certified.