

TDS  
Technical Data Sheet

Release Date  
10 2023



The carefully designed colour scheme and new constructive details of LessLess Color permit the creation of workspaces where the tables, desks, and containers are combined with a high degree of compositional and chromatic freedom.

The tables and desks of this family of furnishings feature an exclusive worktop with a linoleum insert in the same colour as the aluminium frame. The tables are also available with a cable management system consisting of cable hatches, cable trays below the top, and legs that double as cable risers.

The LessLess Color series is available in a range of eight colours, complete with metal drawer pedestals and document storage cabinets with doors, in various heights.

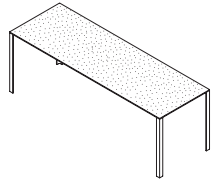

**Tables with depth 70 cm**

140×70×H72 cm  
C LL 140 70 F ..

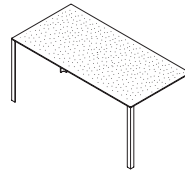

**Tables with depth 80 cm**

160×80×H72 cm  
C LL 160 80 F ..

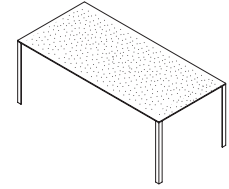

**Tables with depth 90 cm**

190×90×H72 cm  
C LL 190 90 F ..

TABLES

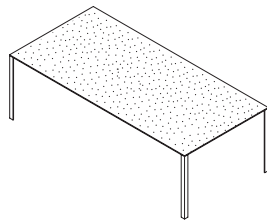

**Tables with depth 110 cm**

230×110×H72 cm  
C LL 230 110 F ..

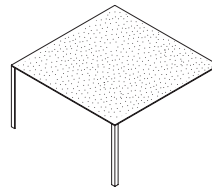

**Square table**

140×140×H72 cm  
C LL 140 140 F .

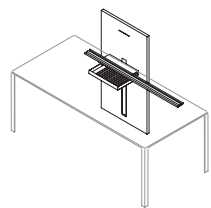

**Structural panel**

65×2,2×H120 cm  
C LL PAN RC ..

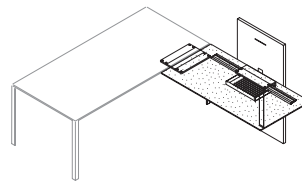

**Extension and structural panel**

140×70×H72 cm  
C LL 140 70L VF ..

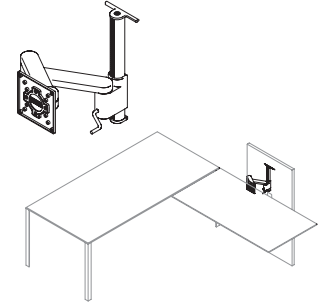
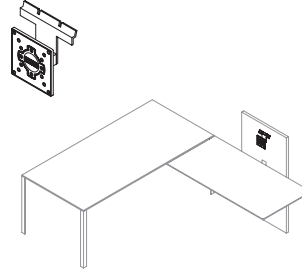
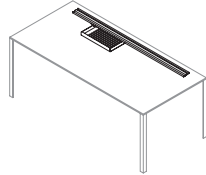

ACCESSORIES

**Cable tray**  
Only black

41x29xH7 cm  
C LL CES ..

**Jointed monitor holder**  
Only black

15x15xH6,6 cm  
C LL AGG MO ..

**Adjustable swing-arm monitor holder**

24x19xH29 cm  
I A FS R2 Z01 ..

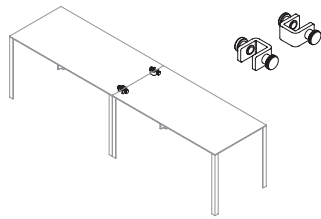

**Pair of clamps for joining tables**  
Only black

4x3,2xH4 cm  
C LL AGG TA ..

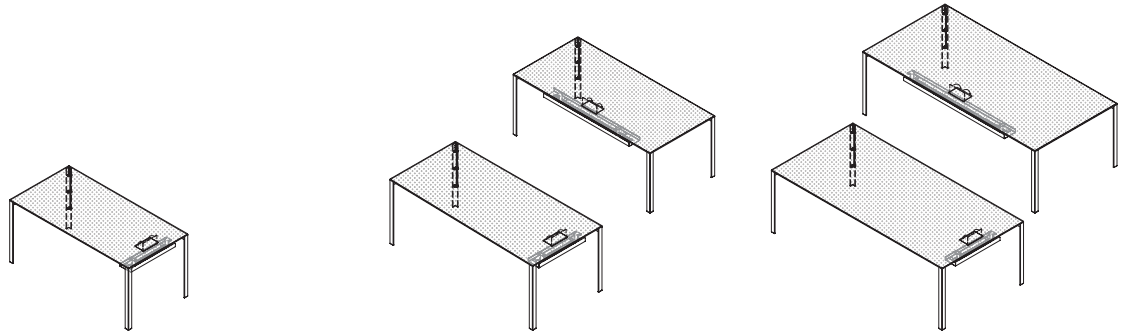
TABLES PRE-ARRANGED  
FOR ELECTRIFICATION**Tables with depth 80 cm,  
with flip access, leg suitable  
for cable entry and cable tray**

Flip access door and cable tray  
(C LL CES 060 L) on the short side  
160×80×H72 cm  
C LM 160 80 F W L ..

**Tables with depth 90 cm,  
with flip access, leg suitable  
for cable entry and cable tray**

Flip access door and cable tray  
(C LL CES 120 C) on the long side  
190×90×H72 cm  
C LM 190 90 F W C ..

**Tables with depth 110 cm,  
with flip access, leg suitable  
for cable entry and cable tray**

Flip access door and cable tray  
(C LL CES 135 C) on the long side  
230×110×H72 cm  
C LM 230 110 F W C ..

Flip access door and cable tray  
(C LL CES 060 L) on the short side  
190×90×H72 cm  
C LM 190 90 F W L ..

Flip access door and cable tray  
(C LL CES 060 L) on the short side  
230×110×H72 cm  
C LM 230 110 F W L ..

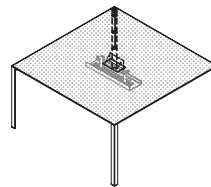
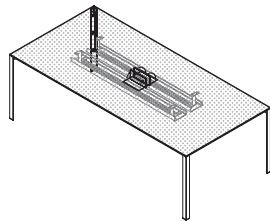
**Tables with depth 110 cm,  
with n.2 centred flip access,  
leg suitable for cable entry  
and n.2 cable trays**

Flip access door and n.2 cable tray  
(C LL CES 135 C) centred on the top  
230×110×H72 cm  
C LM 230 110 F W D ..

**Tables with depth 110 cm,  
with n.2 centred flip access,  
leg suitable for cable entry  
and cable tray**

Flip access door and cable tray  
(C LL CES 060 C) centred on the top  
140×140×H72 cm  
C LM 140 140 F W C ..

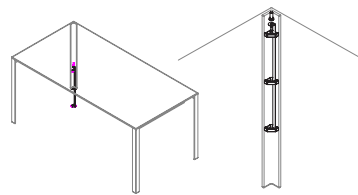
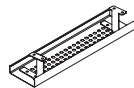

## ELECTRIFICATION

**Cable tray for table  
with flip access door**

For table (C LL 160 80 F S L),  
(C LL 190 90 F S L), (C LL 230 110 F S L)  
60×15×H4 cm  
C LL CES 060 L ..

For table (C LL 140 140 F S C)  
60×15×H4 cm  
C LL CES 060 C ..

For table (C LL 190 90 F S C)  
120×15×H4 cm  
C LL CES 120 C ..

For table (C LL 230 110 F S C),  
(C LL 230 110 F S L)  
135×15×H4 cm  
C LL CES 135 C ..

**Leg predisposition for cables**  
Only black

C LLA SC ..

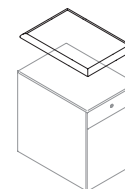
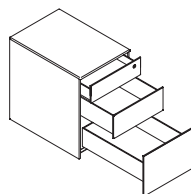
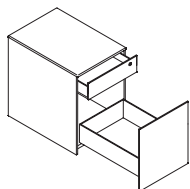

CABINETS

**2 drawers pedestal**  
On wheels only

37x53xH53,5 cm  
C LL 37 53 C2N ..

**3 drawers pedestal**  
On wheels only

37x53xH53,5 cm  
C LL 37 53 C3N ..

**Cushion for pedestal**

37x53xH3 cm  
C LL CUS 37 ..

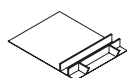

**Storage tray**  
Only transparent

32x42xH4,2 cm  
D DS 532 ..

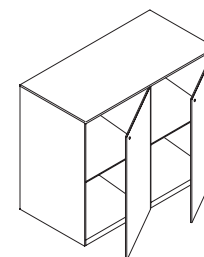
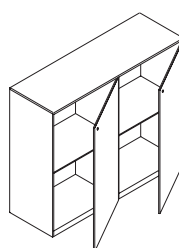
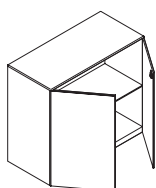

**Cabinet with doors width 80 cm, depth 37,5 cm**  
n.1 internal shelf

80x37,5xH53 cm  
C LL 080 072 MA M ..

**Cabinet with doors width 110 cm, depth 37,5 cm**  
n.2 internal shelves

110x37,5xH53 cm  
C LL 110 053 MA M ..

110x37,5xH91 cm  
C LL 110 091 MA M ..

110x37,5xH128 cm  
C LL 110 128 MA M ..

**Cabinet with doors width 110 cm, depth 45 cm (USA)**  
n.2 internal shelves

110x45xH53 cm  
C LL 110 053 MA 4M ..

110x45xH91 cm  
C LL 110 091 MA 4M ..

110x45xH128 cm  
C LL 110 128 MA 4M ..

**TABLES FINISHES**

Table top: Linoleum  
Structure: Epoxy powder coating



**U0/D4**  
Salsa linoleum (U0)  
Salsa painting (D4)



**U3/D7**  
Charcoal linoleum (U3)  
Charcoal painting (D7)



**U4/FU**  
Mushroom linoleum (U4)  
Mushroom painting (FU)



**U8/3T**  
Pebble linoleum (U8)  
Pebble painting (3T)



**U9/T0**  
Ash linoleum (U9)  
Ash painting (T0)



**UD/FW**  
Mauve linoleum (UD)  
Mauve painting (FW)



**UE/FX**  
Conifer linoleum (UE)  
Conifer painting (FX)



**UF/T2**  
Black linoleum (UF)  
Nero painting (T2)

**CABINETS FINISHES**

Epoxy powder coating



**D4**  
Salsa painting



**D7**  
Charcoal painting



**FU**  
Mushroom painting



**3T**  
Pebble painting



**T0**  
Ash painting



**FW**  
Mauve painting



**FX**  
Conifer painting



**T2**  
Black painting

**CUSHION FINISHES**

Fabric



**TE**  
Black Scuba fabric

**ACCESSORIES AND MONITOR SUPPORT ARM FINISHES**

Epoxy powder coating



**KS**  
Soft Black painting

For other finishes,  
please contact our Sales Department





ISO 9001



ISO 14001

UniFor has management system certified according to UNI EN ISO 9001 and UNI EN ISO 14001. The products are in conformance with the Italian decree law DLGS 81:2008 and with all of the principal regulations applicable to the various types of products.

The products described in this catalog are made with class E1 materials (low formaldehyde content) and are Greenguard® certified.