

TDS
Technical Data Sheet

Release Date
10 2023



The LessLess series, an evolution of Less, consists of tables, workstations with additional worktops, drawer pedestals and containers characterised by minimalist forms and intended for task areas, executive offices, meeting and conference rooms that require a touch of refined elegance.

Tables

The table takes the form of a monolithic structure made entirely of aluminium; the legs consist of extruded L-shaped profiles, while the top is built from folded sheet-aluminium. The legs and top are attached by means of a special fastening system that ensures both safety and high technical performance.

The tops are available in rectangular or square formats in various sizes, with an anodised finish painted in soft black. The additional worktops, attached by means of connecting elements between the tops, are supported by a single vertical structural panel designed to accommodate a monitor and a cable management system.

Drawer pedestals and cabinets

Enhanced by minimalist forms and carefully designed constructive details, the drawer pedestal on wheels and the modular cabinets are constructed with a concealed base, back and sides enclosed by a single panel, and doors equipped with push-open devices.

The LessLess containers are available in three heights in the freestanding version, as well as a wall-hung version (only 53 cm high). With the addition of cushions in black high-tech fabric, the drawer pedestals and low cabinets can also be used as comfortable seating.

Totem

Conceived as a formally rigorous monolith, the LessLess totem is an innovative swivel tower cabinet on a fixed base that takes the form of a smooth and compact rectangular solid, thanks to the visual concealment of the fixed base.

Accessible on two sides to make good use of its depth, it is equipped with a unique hidden door-opening mechanism, with rotation and lateral translation. Totem, drawer pedestals and cabinets, can be supplied, on request at additional cost, in the same colours as the LessLess Color series.

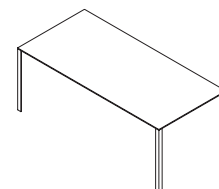
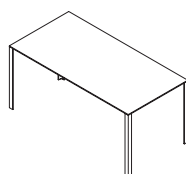
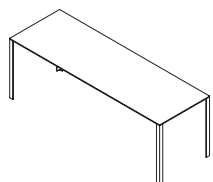

TABLES

Tables with depth 70 cm

140x70xH72 cm
C LL 140 70 ..

210x70xH72 cm
C LL 210 70 ..

280x70xH72 cm
C LL 280 70 ..

Tables with depth 80 cm

160x80xH72 cm
C LL 160 80 ..

Tables with depth 90 cm

190x90xH72 cm
C LL 190 90 ..

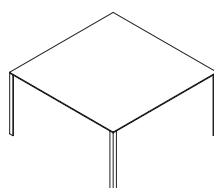
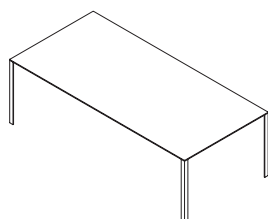

Tables with depth 110 cm

230x110xH72 cm
C LL 230 110 ..

Square table

140x140xH72 cm
C LL 140 140 ..

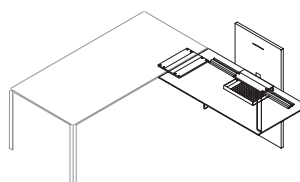
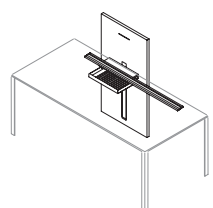

Structural panel

65x2,2xH120 cm
C LL PAN RC ..

Extension and structural panel

140x70xH72 cm
C LL 140 70 LV ..

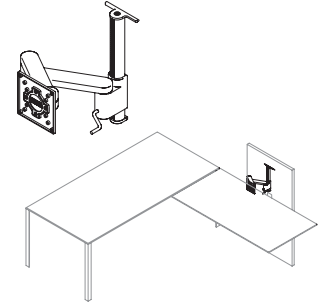
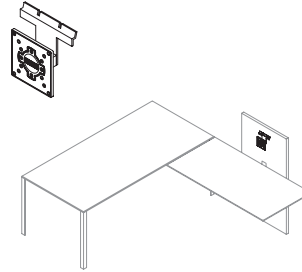
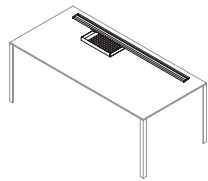

ACCESSORIES

Cable tray
Only Black

41x29xH7 cm
C LL CES ..

Jointed monitor holder
Only Black

15x15xH6,6 cm
C LL AGG MO ..

Adjustable swing-arm monitor holder

24x19xH29 cm
I A FS R2 Z01 ..

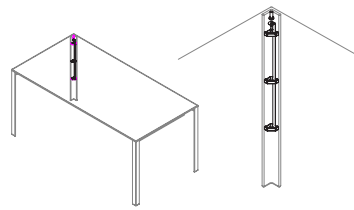
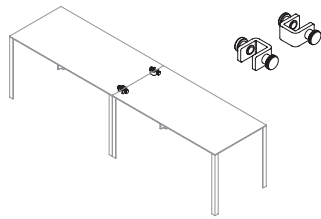

Pair of clamps for joining tables
Only Black

4x3,2xH4 cm
C LL AGG TA ..

Leg predisposition for cables
Only Black

C LL A SC ..

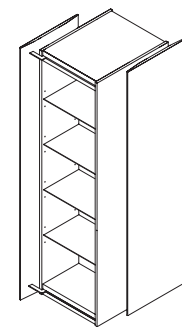
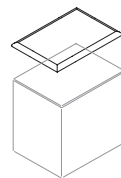
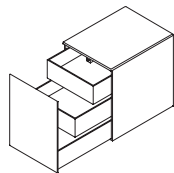

CABINETS

Pedestal
Only on wheels

37x53xH53,5 cm
C LL 37 53 C3S ..

Cushion for cabinet
(C LL 37 53 C3S)

37x53xH3 cm
C LL CUS 37 ..

Rotating tower cabinet, double-sided

55x70xH203 cm
C LL 55 203 ..

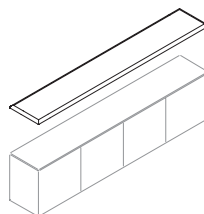
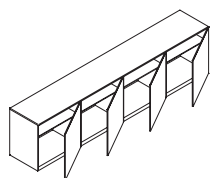

CABINETS

Cabinet with doors height 53 cm
n.4 internal shelves

220×37×H53 cm
C LL 220 053 MA ..

Cushion for cabinet with doors
(C LL 220 053 MA)

220×37×H3 cm
C LL CUS 220 ..

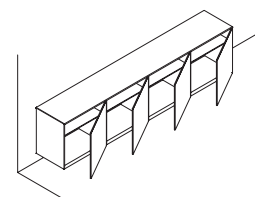
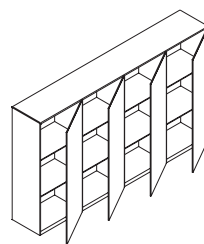
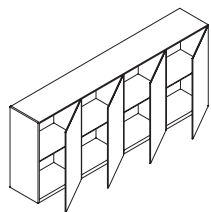

Cabinet with doors height 91 cm
n.4 internal shelves

220×37×H91 cm
C LL 220 091 MA ..

Cabinet with doors height 128 cm
n.8 internal shelves

220×37×H128 cm
C LL 220 128 MA ..

Wall-hung cabinet with doors
to be fixed on wall, maxi weight: 109 kg/ml
n.4 internal shelves

220×37×H53 cm
C LL 220 053 MP ..

TABLES AND CABINETS FINISHES

Liquid coating

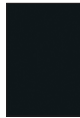

KS
Soft Black painting



EW
Natural anodized painting

**ACCESSORIES
AND MONITOR ARMS FINISHES**

Liquid coating



PX
Frosted Silver painting



KS
Soft Black painting

CUSHION FINISHES

Fabric

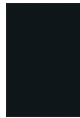

TE
Black Scuba fabric

For other finishes,
please contact our Sales Department



ISO 9001



ISO 14001

UniFor has management system certified according to UNI EN ISO 9001 and UNI EN ISO 14001. The products are in conformance with the Italian decree law DLGS 81:2008 and with all of the principal regulations applicable to the various types of products.

The products described in this catalog are made with class E1 materials (low formaldehyde content) and are Greenguard® certified.