

TDS
Technical Data Sheet

Release Date
10 2023



Modular office system consisting of tables, desks, and divider panels designed to organise the contemporary office space in response to the different requirements of operational functionality.

The tops, 3 cm thick, are available with a melamine, laminate, or natural wood finish. Two aluminium profiles, which serve as both stabilizing beams and connecting elements, are fixed to the undersides of the tops.

The vertical supports, legs or drawer pedestals, can slide freely along the entire length of the profiles, allowing them to be positioned as desired. The profiles also serve to attach a series of accessories, including monitors, modesty panels, and brackets in extruded aluminium for connecting the additional worktops in a linear or L configuration.

This bridge-type assembly system makes it possible to eliminate the number of joints and to avoid the need to double the number of legs when adding work surfaces.

The vertical supports, available in T-shaped legs or as solid panels, are height adjustable by means of a manual or electric control device. They can be substituted by fixed drawer pedestals mounted with a special connecting system.

The height of the legs can vary from 72 cm to 102 cm in the manual version and from 65.5 cm to 125 cm in the electric version. Both types of vertical supports are also available in fixed-height versions.

The system is completed by cable trays positioned below the tops. The height adjustment controls and housing for the electrical boxes are also positioned below the tops.

The Misura series also includes round and square meeting tables.

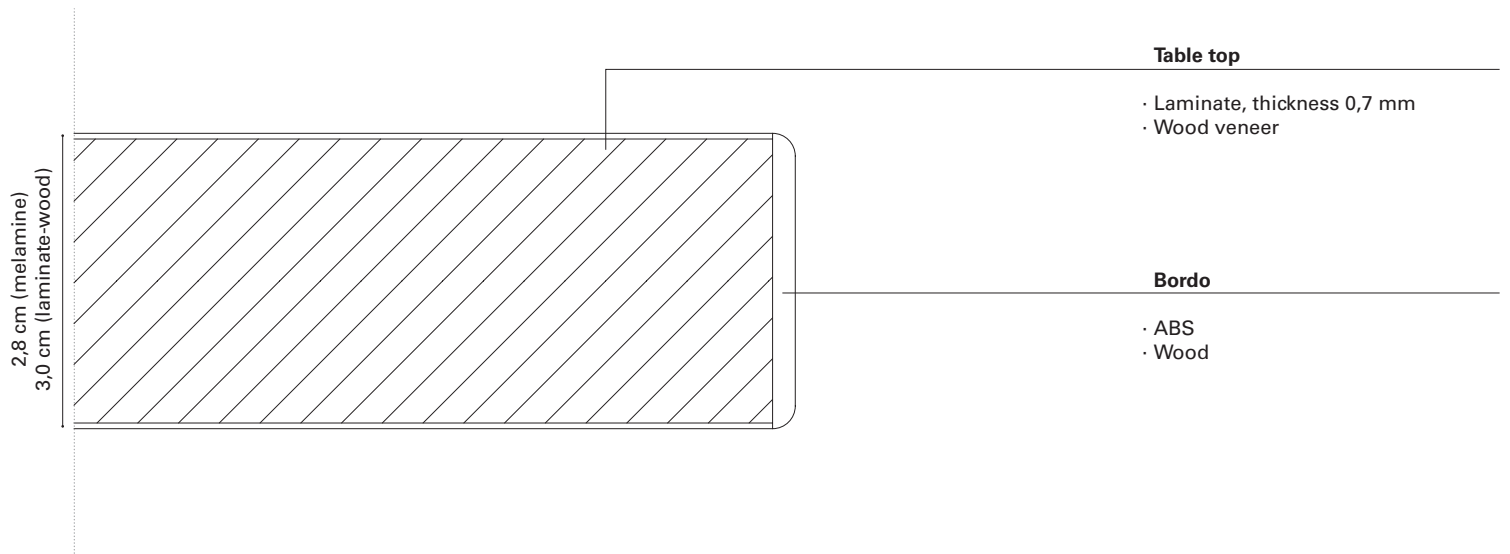
**Table top**

- Laminate, thickness 0,7 mm
- Wood veneer

Bordo

- ABS
- Wood

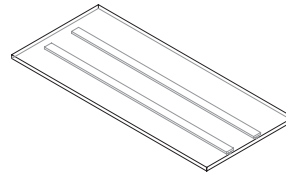
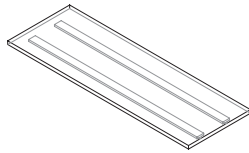
**TABLETOPS****Rectangular tops
60 cm depth**

80×60×H3 cm
I ST 080 60 ..

100×60×H3 cm
I ST 100 60 ..

140×60×H3 cm
I ST 140 60 ..

160×60×H3 cm
I ST 160 60 ..

180×60×H3 cm
I ST 180 60 ..

240×60×H3 cm
I ST 240 60 ..

**Piani rettangolari
80 cm depth**

120×80×H3 cm
I ST 120 80 ..

140×80×H3 cm
I ST 140 80 ..

160×80×H3 cm
I ST 160 80 ..

180×80×H3 cm
I ST 180 80 ..

200×80×H3 cm
I ST 200 80 ..

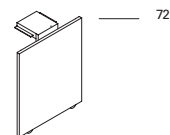
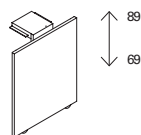
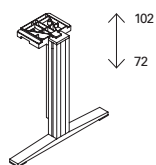

TABLE TOPS STRUCTURES

Manual height-adjustable T-leg, from 72 cm to 102 cm above the top

For table tops depth 60 cm
55x6xH72/102 cm
I ST GM 3 ..

For table tops depth 80 cm
65x6xH72/102 cm
I ST GM 1 ..

Manual height-adjustable slab leg, from 69 cm to 89 cm above the top

For table tops depth 60 cm
55x2,2xH69/89 cm
Q EM S 55 ..

For table tops depth 80 cm
70x2,2xH69/89 cm
Q EM S 70 ..

Fixed slab leg

For table tops depth 60 cm
55x2,2xH69/89 cm
Q EM S 55 F.

For table tops depth 80 cm
70x2,2xH69/89 cm
Q EM S 70 F.

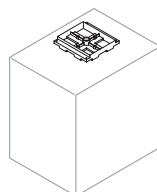
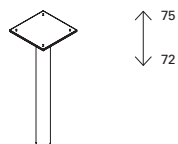

Height -adjustable cylindrical leg

6,5x6,5xH72/75 cm
I ST PP 4 ..

Pedestal support, height-adjustable in three positions, H69/72/75 cm

23x23xH7 cm
I R CQ ..

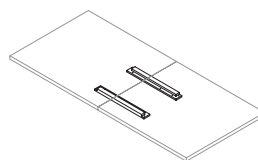
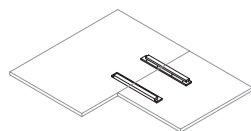

Connecting fork for orthogonal tables tops
Shadow Grey only (GO)

7x50xH4 cm
I ST DG ..

Connecting fork for aligned table tops
Shadow Grey only (GO)

4x44xH3 cm
I ST GS ..

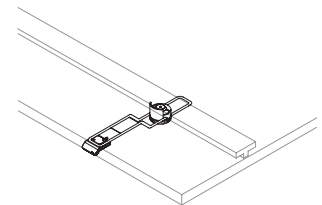
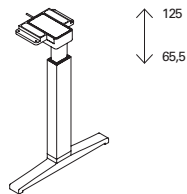

ELECTRICAL STRUCTURES FOR TABLE TOPS WITH T-LEGS

Electrically height-adjustable T-leg from 65,5 cm to 125 cm above the top

For table tops depth 60 cm, motor and cap, Black only
55x6xH65,5/125 cm
I ST GM 3 E..

For table tops depth 80 cm, motor and cap, Black only
65x6xH65,5/125 cm
I ST GM 1 E ..

Control unit kit and cables

Control unit kit and cables (UE)
I ST GM KC EU

Control unit kit and cables (CH)
I ST GM KC CH

Control unit kit and cables (AUS)
I ST GM KC AU

Control unit kit and cables (USA)
I ST GM KC US

Control unit kit and cables (JP)
I ST GM KC JP

Control unit kit and cables (UK/SG)
ST GM KC GB

Switch

Only black

Simple switch
I ST GM PU S ..

Control panel with memory and display
I ST GM PU MD ..

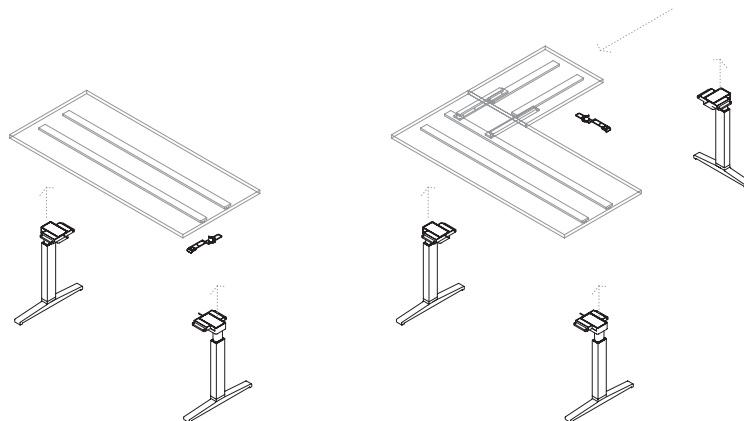

COMPOSITIONS WITH T LEGS

Single workstation composition

- n.2 T legs
I ST GM 1 E ..
- n.1 control unit kit and cables
I ST GM KC ..
- n.1 switch
I ST GM PU ..

L-shape desk composition

- n.2 T legs
I ST GM 1 E ..
- n.1 T legs
I ST GM 3 E ..
- n.1 control unit kit and cables
I ST GM KC ..
- n.1 switch
I ST GM PU ..

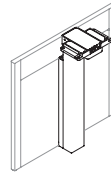
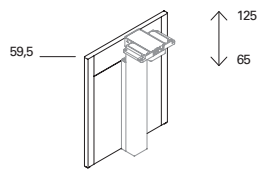

ELECTRICAL STRUCTURES FOR TABLE TOPS WITH SLABS LEGS

Electrically height-adjustable slab leg from 65,5 cm to 125 cm over the top

For table tops depth 60 cm
55x2,2xH65,5/125 cm
Q EM S 55 P ..

For table tops depth 80 cm
70x2,2xH65,5/125 cm
Q EM S 70 P ..

Motorized head for slab leg 59,5 cm
Black only

Q EM S 18 E B ..

Control unit kit and cables

Control unit kit and cables (UE)
I ST GM KC EU

Control unit kit and cables (CH)
I ST GM KC CH

Control unit kit and cables (AUS)
I ST GM KC AU

Control unit kit and cables (USA)
I ST GM KC US

Control unit kit and cables (JP)
I ST GM KC JP

Control unit kit and cables (UK/SG)
ST GM KC GB

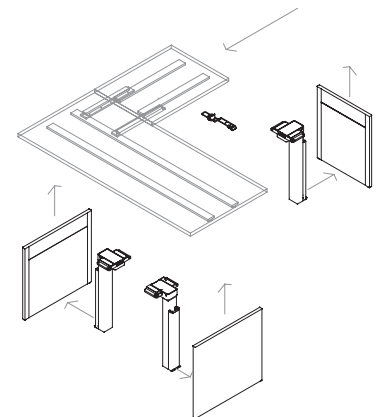
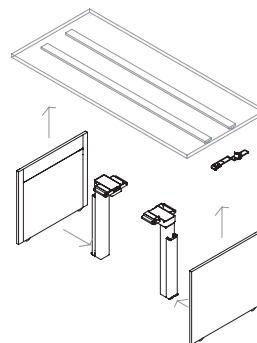
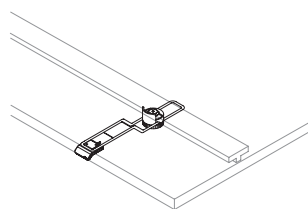

Switch
Only black

Simple switch
Q EM S PU S ..

Control panel with memory and display
Q EM S PU MD ..

Single workstation composition

n.2 adjustable slab legs
Q EM S 70 P ..

n.2 motorized head
Q EM S 18 E B ..

n.1 control unit kit and cables
Q EM S KC B ..

n.1 switch
Q EM S PU ..

L-shape desk composition

n.2 adjustable slab legs
Q EM S 70 P ..

n.1 adjustable slab legs
Q EM S 55 P ..

n.3 motorized head
Q EM S 18 E B ..

n.1 control unit kit and cables
Q EM S KC B ..

n.1 switch
Q EM S PU ..

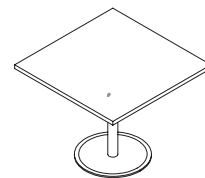
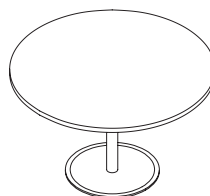
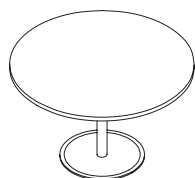

MEETING TABLES

**Round tables composed of
n.1 table top (ITR 090),
n.1 leg (B BS 50 68)**

90×90×H72 cm
I TM 090 R ..

**Round tables composed of
n.1 table top (ITR 120),
n.1 leg (B BS 50 68)**

120×120×H72 cm
I TM 120 R ..

**Square tables composed of
n.1 table top (ITQ 090),
n.1 leg (B BS 50 68)**

90×90×H72 cm
I TM 090 Q ..

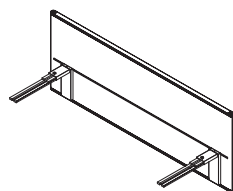

HANGING SCREENS

Hanging screens in fabric

125×3,3×H61 cm
I ST PB 125 ..

140×3,3×H61 cm
I ST PB 140 ..

160×3,3×H61 cm
I ST PB 160 ..

180×3,3×H61 cm
I ST PB 180 ..

200×3,3×H61 cm
I ST PB 200 ..

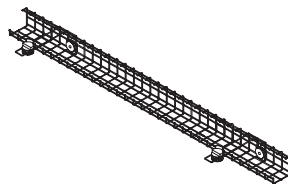
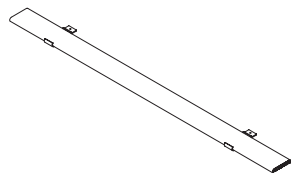

ELECTRIFICATION

Wire channel under table

Black only

88x9,7xH3 cm
I B 6 100 ST ..

136x9,7xH3 cm
I B 6 150 ST ..

Cable tray

75x10,5xH10,5 cm
I WB 075 P ..

100x10,5xH10,5 cm
I WB 100 P ..

125x10,5xH10,5 cm
I WB 125 P ..

150x10,5xH10,5 cm
I WB 150 P ..

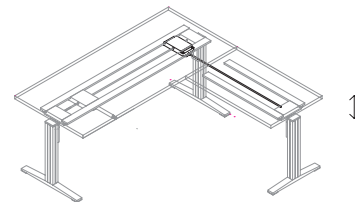
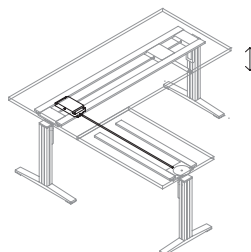
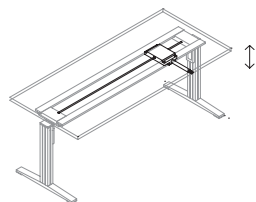

ACCESSORIES

Manual table height adjustment device

Trasparent only

For table tops depth 60 cm
23x15xH4 cm
I A DRA 60 ..

For table tops depth 80 cm
23x15xH4 cm
I A DRA 80 ..

Left device for return

23x15xH4 cm
I A DRA R S ..

Right device for return

23x15xH4 cm
I A DRA R D ..

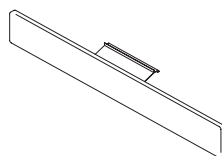
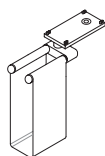

ACCESSORIES

CPU holder

Shadow Grey only

30x14/17xH36/53 cm
IA UNI ..

Modesty panel H20 cm

Shadow Grey only

100x2xH20 cm ST PF 100 ..	125x2xH20 cm ST PF 125 ..
150x2xH20 cm ST PF 150 ..	175x2xH20 cm ST PF 175 ..

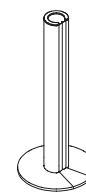

CABLES RISER

Flexible cable riser with side zipper

Only black

7x1xH67 cm
IA SCF ET ..

Flexible cable riser

Only transparent

13x13xH60 cm
IA SCF B ..

Round cables riser

25x25xH43,5 cm
IA SC Z02 ..

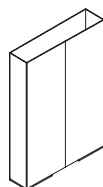
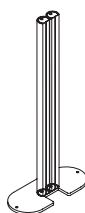

Cables riser

27,8x12xH53,5 cm
IA SC Z17 ..

Cables riser cover

Only Chrome painted (3C)

34,8x8xH55,4 cm
Y NO A SC Z01 ..

TABLE TOPS AND COMBINATIONS
TABLE TOPS/STRUCTURES FINISHES
 (Structure in: BA- NA)

Melamine



4S
 White melamine



PN
 Platinum Grey melamine



NY
 Oak melamine

Laminate

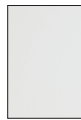

S4
 White laminate



GP
 Platinum Grey laminate



X0
 Fenix White laminate



X1
 Fenix Black laminate

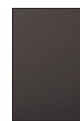

X2
 Fenix Cacao laminate



X3
 Fenix Grey laminate

Photolaminate



LS
 Sycamore laminate



RY
 Natural Oak laminate

Standard natural veneer
 (certified genuine wood
 from Europe - Canada - USA)



AS
 Sycamore



RV
 Natural Oak

For other finishes,
 please contact our Sales Department

STRUCTURES, ELECTRIFICATION AND ACCESSORIES FINISHES

Epoxy powder coating



D7
Charcoal painting



T0
Ash painting



VP
Platinum Grey painting



C7
Calce White painting



KS
Soft black painting

HANGING SCREENS FINISHES

Profiles in: D7- T0- VP- C7- KS

Fabric

It is necessary to specify when ordering the finish of the structure



J2
COM fabric



J3
Mirage fabric



Q0
Revive 1 fabric



Q1
Chip fabric



Q2
File fabric



K3
Remix 3 fabric



K4
Sole fabric



ISO 9001



ISO 14001

UniFor has management system certified according to UNI EN ISO 9001 and UNI EN ISO 14001. The products are in conformance with the Italian decree law DLGS 81:2008 and with all of the principal regulations applicable to the various types of products.

The products described in this catalog are made with class E1 materials (low formaldehyde content) and are Greenguard® certified.